

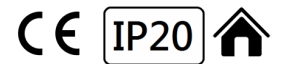



## DURMA

IP20 Max: 15W / 2x15W / 3x15W



## Technical Data

Luminaire Type- 安裝方式 Tipo de luminaria	Recessed Mount and Adjustable Type 嵌入式可調暗裝筒燈 Empotrar y tipo ajustable
Dimension-尺寸-Dimensión	L: 95 x W: 95 x H: 85 mm L: 185 x W: 95 x H: 85 mm L: 275 x W: 95 x H: 85 mm
Cut off Dimension-開孔尺寸-Cortar Dimensión	L: 96 x W: 96 mm L: 187 x W: 96 mm L: 276 x W: 96 mm
Input Voltage-輸入電壓-Voltaje de entrada	AC220-240V 50/60HZ
Power Consumption Max-燈具功率 Consumo de energía Max	95 x 95 x 85 mm 10W / 15W 185 x 95 x 85 mm 2x10W / 2x15W 275 x 95 x 85 mm 3x10W / 3x15W
LED Driver Type LED驅動款式 Tipo de controlador LED	Remote-type LED Driver--Refer to LED driver specification 請參閱LED驅動器規格 Consulte la especificación de controlador de LED 1. 0-10V Dimming Driver AC220-240V 50/60HZ 2. DALI Dimming Driver AC220-240V 50/60HZ 3. Triac AC220-240V 50/60HZ 4. Emergency Backup >2 hours or >3 hours @ < 24 charger hours 應急電池/Copia de seguridad de emergencia
LED Driver Features 驅動特性 Funciones del controlador de LED	EFFICIENCY (Typ.): >90% MAX. No. of PSUs on 16A CIRCUIT BREAKER: 25 units (circuit breaker of type B) / 40 units (circuit breaker of type C at 230VAC)
Control Protocol-控制協議 Protocolo de Control	0-10V / Dali / Triac
Beam Angle 光束角 ángulo de haz	24° 36° 60°
Light Source Brand-光源品牌-Fuente de luz de marca	CREE COB
"Lumen Maintenance LM-80 Reported by TM-21"	1. L90(10k) = 50,700 hrs 2. L80(10k) > 63,500 hrs 3. L70(10k) > 63,500 hrs
LED Life-LED壽命-La vida del LED	>60,000 hours
Color Temperature -色溫 Temperatura del color	2700K / 3000K / 4000K / 5000K / 6500K
Color Rendering Index-顯色指數 Índice de reproducción cromática	>80 >90
MacAdam Ellipses Binning 麥克亞當橢圓分級 Mac Adam binning ellipse	Standard Deviation Colour Matching < 3 SDCM 標準偏差配色 < 3 SDCM Coincidencia de color estándar Desviación < 3 SDCM
Luminaire Efficacy 燈具效率 La eficacia de la luminaria	85 Lm/w(2700K), 90 Lm/w(3000K), 90 Lm/w(4000K), 95 Lm/w(5000K), 95 Lm/w(6500K),
LED Source Luminous Efficacy LED光源光效 Fuente luminosa LED Eficacia	135 Lm/w(2700K), 140 Lm/w(3000K), 140 Lm/w(4000K), 145 Lm/w(5000K), 145 Lm/w(6500K),
Housing materials-外殼材料 Materiales de la carcasa	Die-cast aluminum and acrylic lens 壓鑄鋁和亞克力透鏡 Fundición de aluminio y acrílico lente
Housing Color 外殼顏色 color de la carcasa	Powder Coating :Matte white + black body 粉末塗料: 啞光白色 + 黑色燈身 Recubrimiento en Polvo: Blanco mate + cuerpo negro
Ingress Protection-防護等級 Protección de ingreso	IP20
Environment-使用環境-medio ambiente	Indoor
Operating Humidity -工作濕度 Humedad de funcionamiento	0~90%, non-condensing-不結霜 sin condensación
Operating Temperature Range / 工作溫度範圍 Rango de temperatura de funcionamiento	-30 °C / +50 °C
Comply Testing Standard 符合測試標準 Cumplir el estándar de prueba	LED Luminaires: IEC 60598-1 / IEC 60598-2-2 / Photometric data-IES format LED Driver: EN 55015 / IEC 61000-3-2 / IEC 61347-1 / IEC 61347-2-13 / IEC 61547
Certification-認證-Certificación	  

Project	Fixture#	Date
		Firm



## Ordering Information

Choose the option that suits your need and write its corresponding code on the appropriate line to form the product code.

Example product code: [DURMA-45W](#)

DURMA - - \_\_\_\_\_  
Power Consumption

Power Consumption	
Code	Description
<a href="#">10W / 15W</a>	1x10W / 1x15W
<a href="#">20W / 30W</a>	2x10W / 2x15W
<a href="#">30W / 45W</a>	3x10W / 3x15W

# Beam Angle

10W 3000K 24 °

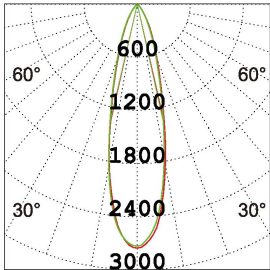

15W 3000K 24 °

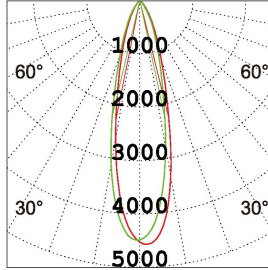

2×10W 3000K 24 °

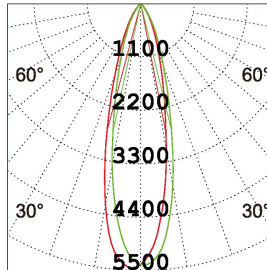

2×15W 3000K 24 °

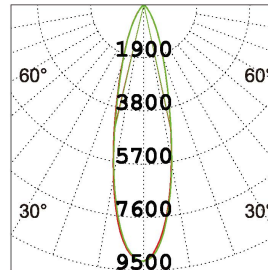

3×10W 3000K 24 °

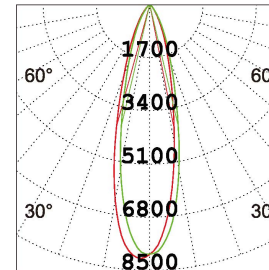

3×15W 3000K 24 °

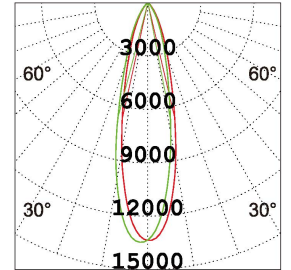

10W 3000K 36 °

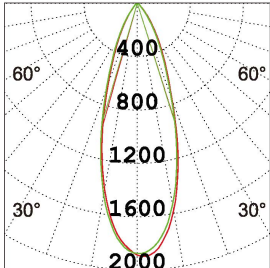

15W 3000K 36 °

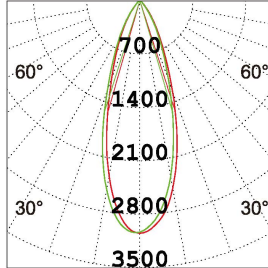

2×10W 3000K 36 °

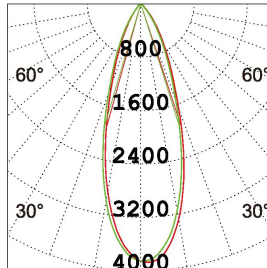

2×15W 3000K 36 °

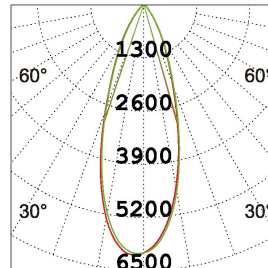

3×10W 3000K 36 °

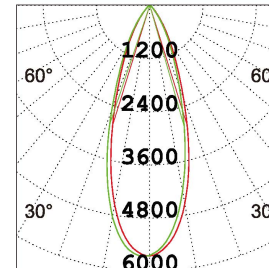

3×15W 3000K 36 °

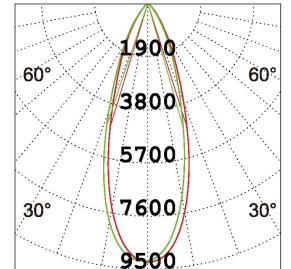

10W 3000K 60 °

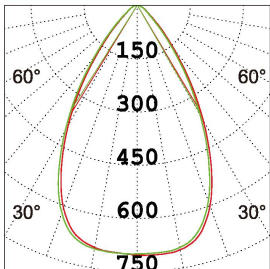

15W 3000K 60 °

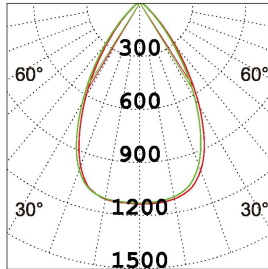

2×10W 3000K 60 °

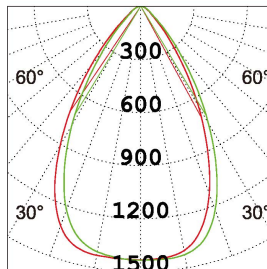

2×15W 3000K 60 °

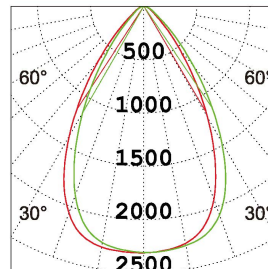

3×10W 3000K 60 °

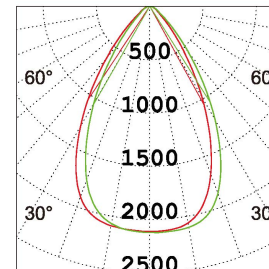

3×15W 3000K 60 °

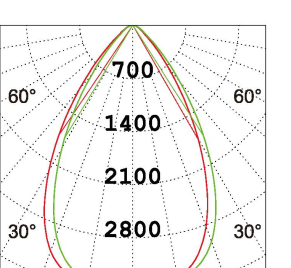

# Technical Drawing

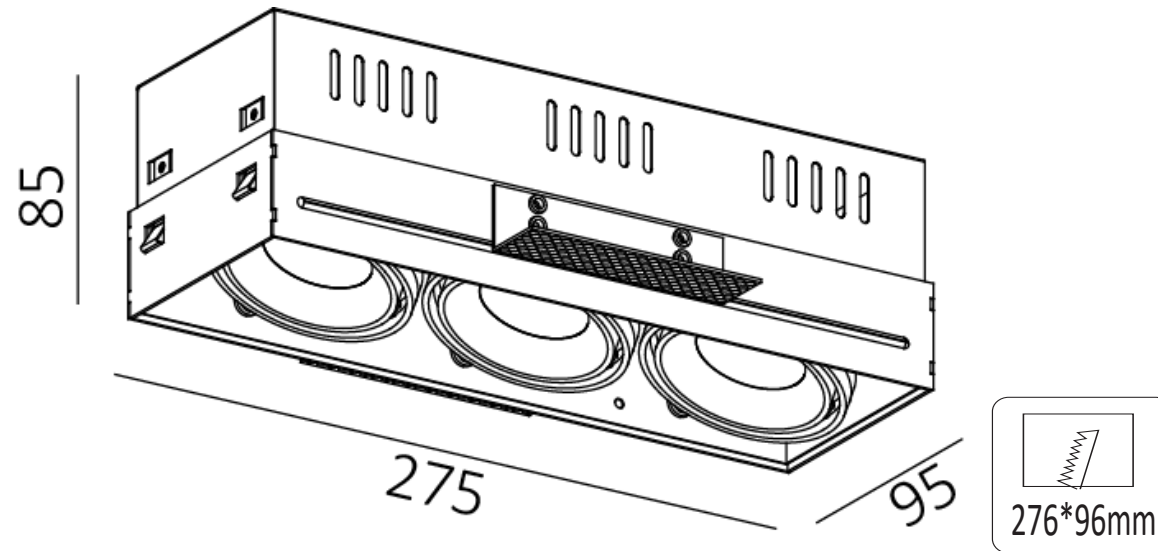
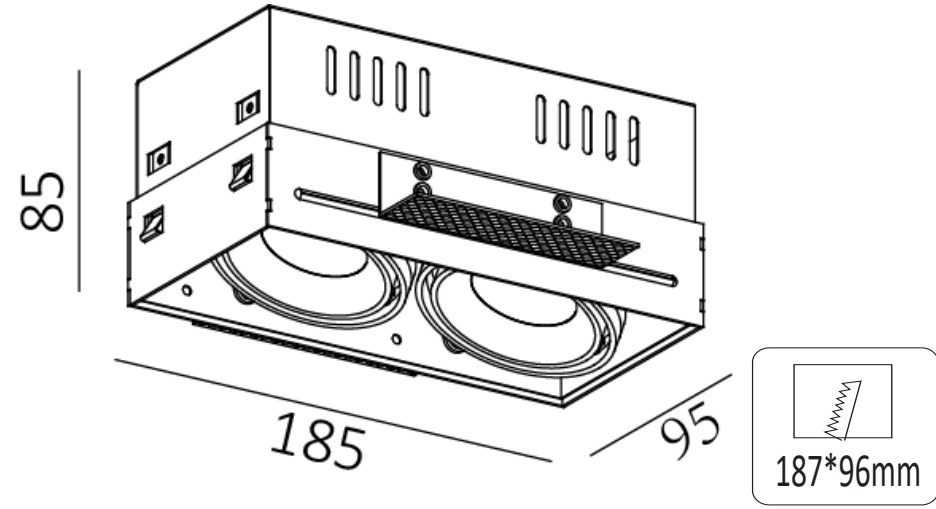
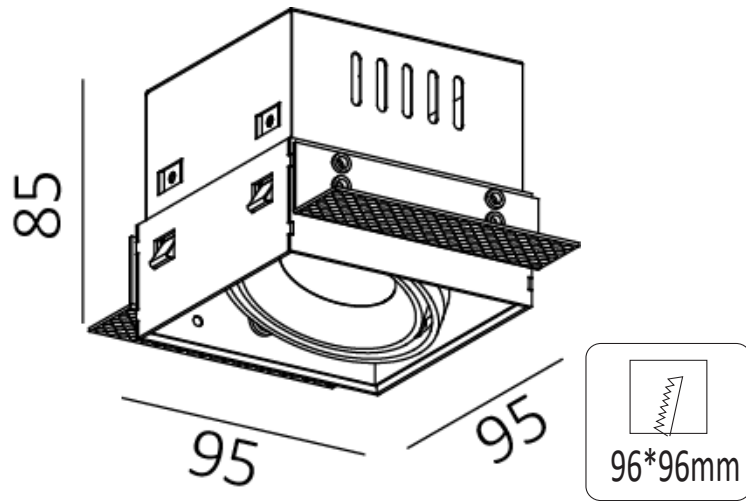

Unit:mm