

DRIZO F & W



CB



IP54

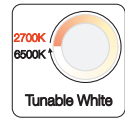

Tunable White 2700-6500K

F-Series

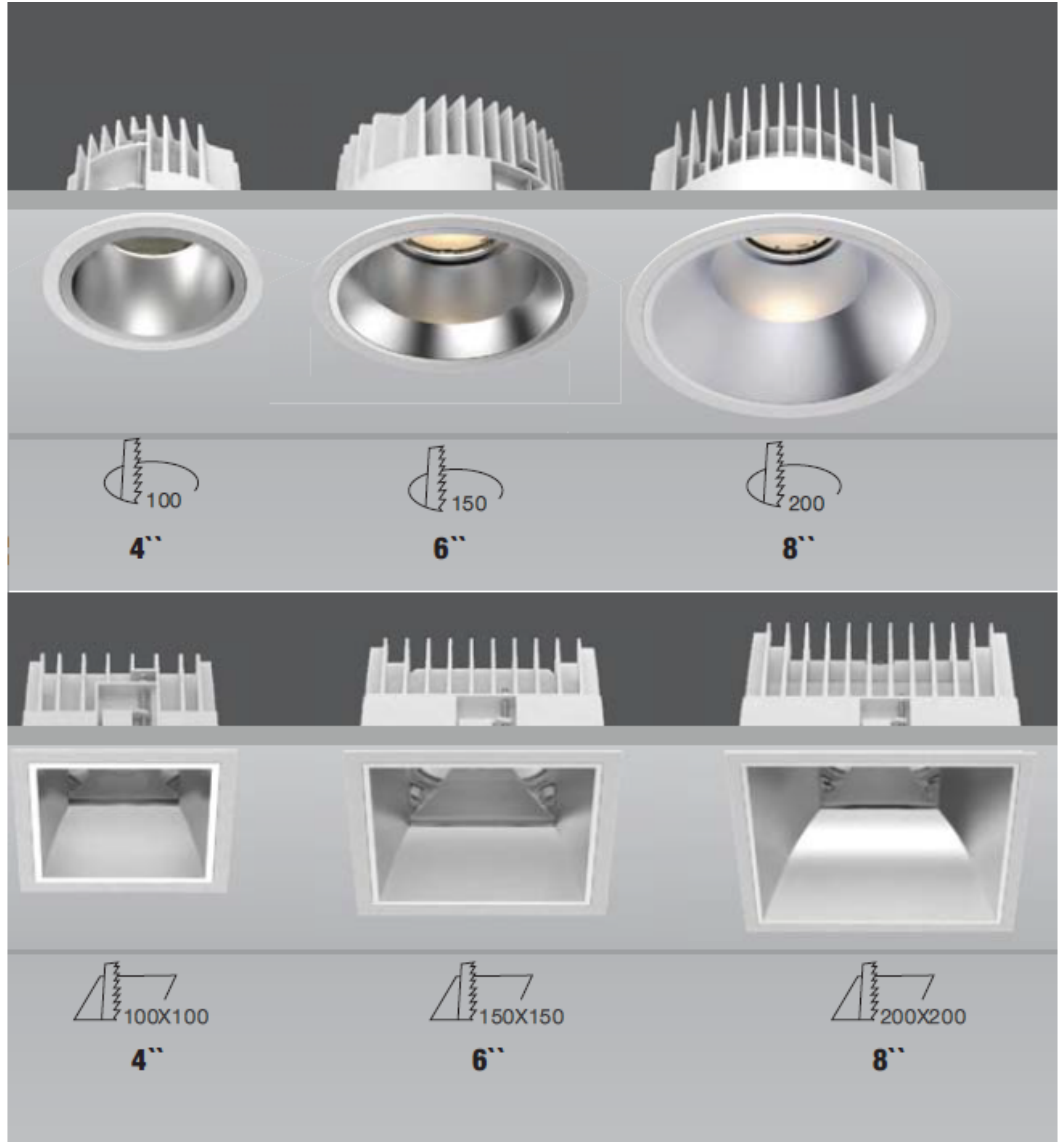
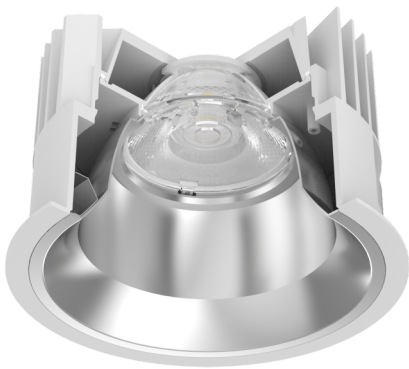

W-Series

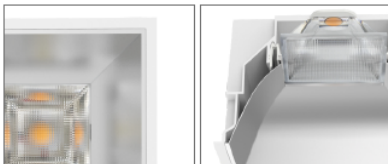

Silver White Black







Dark Specular Gold



Silver White Black

LED RECESSED LOW GLARE DOWN LIGHT. Housing: die-cast aluminium with PMMA Lens and anti-glare reflector to achieve UGR< 19. Deep recessed design achieves supereye comfort. Optimal lens technologies with narrow, medium and flood beam angles .

Technical Data

Luminaire Type-安裝方式Tipo de luminaria	Recessed Mount Type 嵌入式筒燈Empotrada Tipo Mount		
Dimension-尺寸-Dimensión Cut off Dimension-開孔尺寸-Cortar Dimensión	<p>F Series:</p> <ul style="list-style-type: none"> • Dia 110 x H: 79mm Cut-off: 100mm • Dia 160 x H:100mm Cut-off: 150mm • Dia 218 x H:132mm Cut-off: 200mm <p>W Series</p> <ul style="list-style-type: none"> • 110x110xH:79mm Cut-off: 100x100mm • 167x167xH:100mm Cut-off: 150x150mm • 220x220x H:132mm Cut-off: 200x200mm 		
Input Voltage-輸入電壓-Voltaje de entrada	AC100-240V 50/60HZ		
Power Consumption Max-燈具功率 Consumo de energía Max	<p>F Series:</p> <ul style="list-style-type: none"> • 12W @ Dia 110 x H: 79mm 15W @ Dia 110 x H: 79mm • 21W @ Dia 160 x H:100mm 24W @ Dia 160 x H:100mm • 28W @ Dia 218 x H:132mm <p>W Series</p> <ul style="list-style-type: none"> • 12W @ 110x110mm 15W @ 110x110mm • 21W @167x167mm 24W @167x167mm • 28W @ 220x220mm 		
LED Driver Type LED驅動款式 Tipo de controlador LED	<p>Remote-type LED Driver--Constant Current LED Driver: Refer to LED driver specification 請參閱LED驅動器規格 Consulte la especificación de controlador de LED</p> <p>1. Dali Dimming Driver AC100-240V 50/60HZ 2. Emergency Backup >2 hours or >3 hours 應急電池/Copia de seguridad de emergencia</p>		
LED Driver Type LED驅動款式 Tipo de controlador LED Driver	POWER FACTOR : PF>0.9 @ Full Load TOTAL HARMONIC DISTORTION: THD< 20%		
Beam Angle 光束角 /ángulo de haz	60°		
Light Source Brand-光源品牌-Fuente de luz de marca	U.S.A Bridgelux LED Tunable White COB		
"Lumen Maintenance LM-80 Reported by TM-21"@ 25°C	L70(10k) > 60,000 hrs		
LED Life-LED壽命-La vida del LED	>60,000 hours		
Color Temperature -色溫 Temperatura del color	Tunable White 2700K to 6500K		
Color Rendering Index-顯色指數 Índice de reproducción cromática	>90		
Chromaticity Tolerance (initial Macadam) 色度容差 (初始Macadam) Tolerancia de cromaticidad (Macadam inicial)	<p>Standard Deviation Colour Matching < 3 SDCM 標準偏差配色< 3 SDCM Coincidencia de color estándar Desviación < 3 SDCM</p>		
Luminaire Efficacy燈具效率 La eficacia de la luminaria	85lm/w		
LED Source Luminous Efficacy LED光源光效 Fuente luminosa LED Eficacia	120 lm/w		
Housing materials-外殼材料 Materiales de la carcasa	<p>Die-cast aluminum and PMMA Lens and Polycarbonate Reflector 壓鑄鋁和PMMA 透鏡和 PC反光杯 Lente de aluminio fundido a presión y PMMA y reflector de policarbonato</p>		
Trim Color-框邊顏色-Estilo Color	Matte white / Matte black 啞光白色 / 啞光黑色 Blanco mate / Matte black		
Reflector Color-反光杯顏色-Reflector color	<p>Matte Silver 啞銀Plata mate Black 黑色 Negro White 白色 Blanco Dark Specular 亮黑色Especular oscuro Gold 金色 Oro</p>		
Ingress Protection-防護等級 Protección de ingreso	IP54		
Operating Humidity -工作濕度 Humedad de funcionamiento	0~90%, non-condensing-不結霜 sin condensación		
Operating Temperature Range / 工作溫度範圍 Rango de temperatura de funcionamiento	-30 °C / +50 °C		
Comply Testing Standard 符合測試標準 Cumplir el estándar de prueba	<p>LED Luminaires: IEC/EN 60598-1 ; IEC/EN 60598-2-2 ; IEC/ EN62493 ; IEC/EN 62301 ; IEC TR 62778 & IEC 62471 (RG0) LED Driver: EN 55015 / IEC 61000-3-2 / IEC 61347-1 / IEC 61347-2-13 / IEC 61547</p>		
Certification-認證-Certificación	    		

Project	Fixture#	Date
		Firm



Ordering Information

Choose the option that suits your need and write its corresponding code on the appropriate line to form the product code.

Example product code: [DRIZO-F-28W](#)

DRIZO-F-W - -
Series Power Consumption

Series		Power Consumption	
Code	Description	Code	Description
F	F Series	12W	12W
W	W Series	15W	15W
		21W	21W
		24W	24W
		28W	28W

BEAM ANGLE

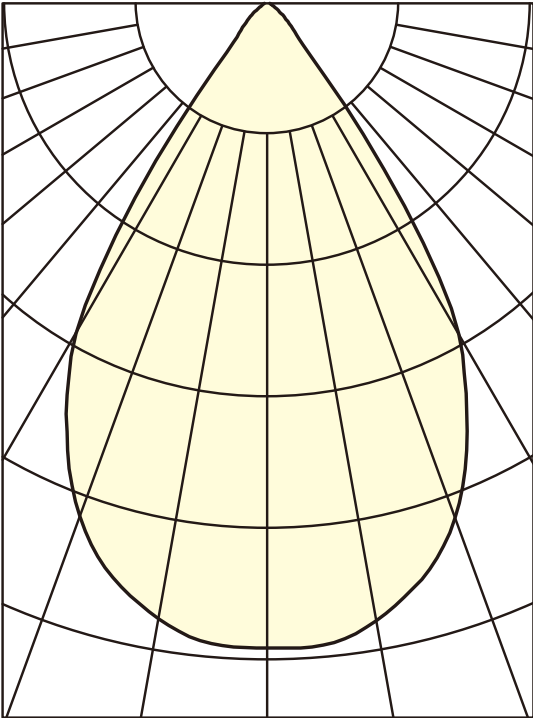
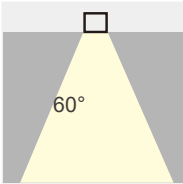

Technical Drawing

F Series :

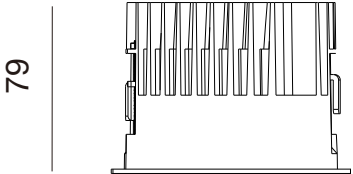

Ø110

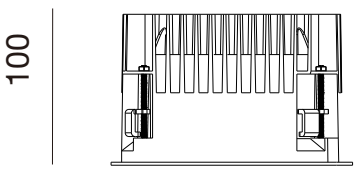

Ø160

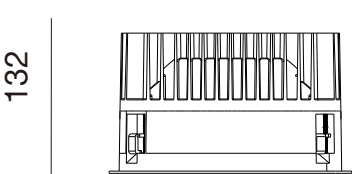

Ø218



W-Series :

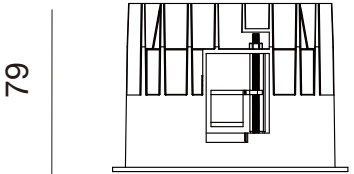

110x110

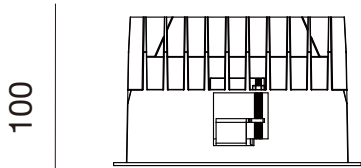
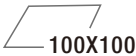

167x167

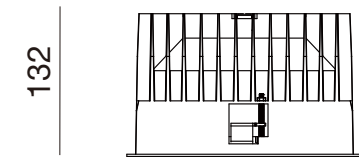
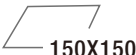

220x220



Interchangeable reflector :



Our Design-DRIZO-W Series

CB IP54 UGR <19

DIMON
TECHNOLOGY

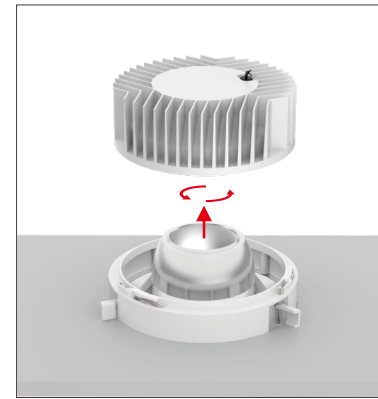
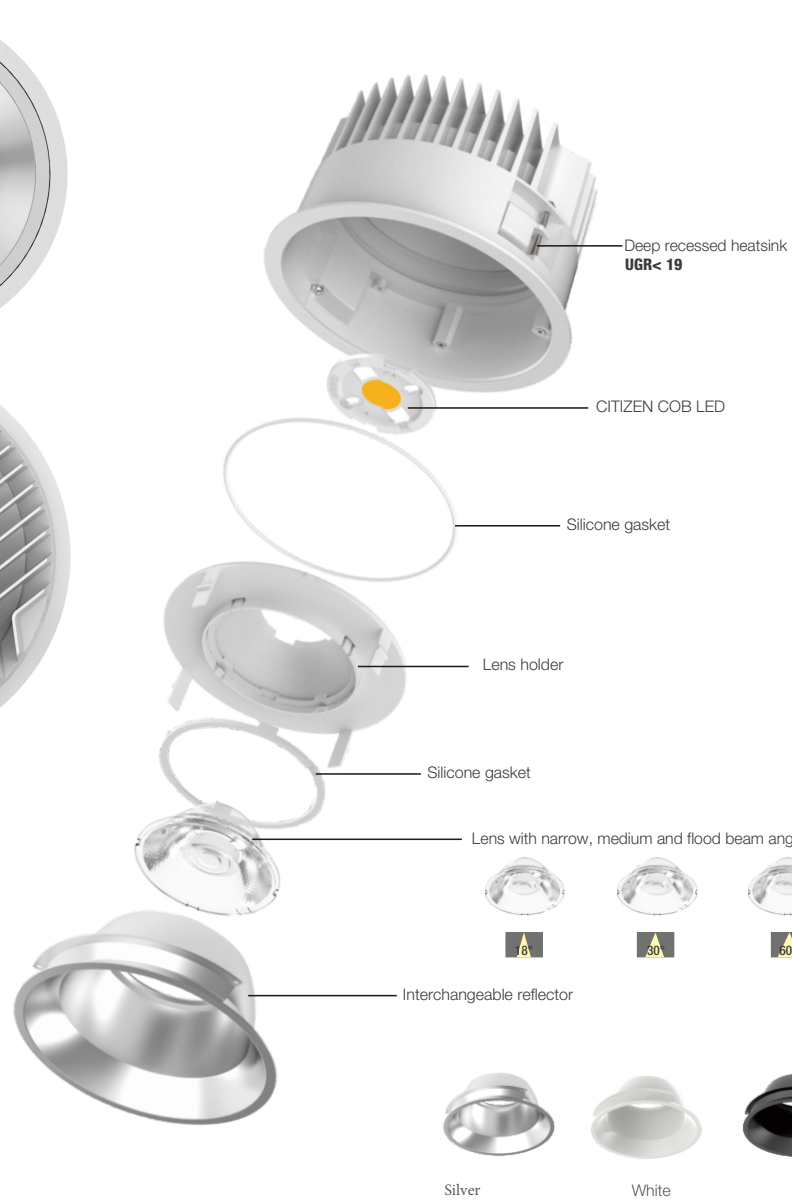
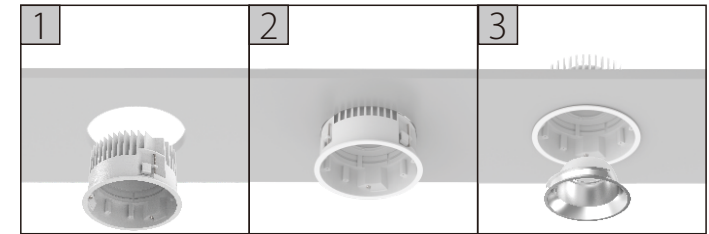

easy maintenance.

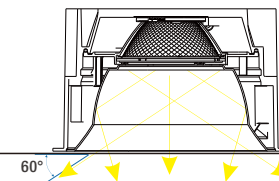
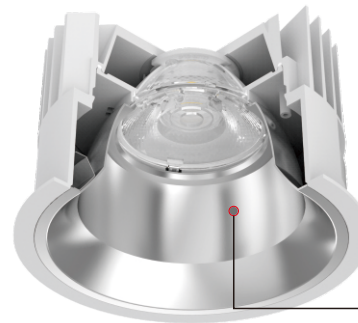
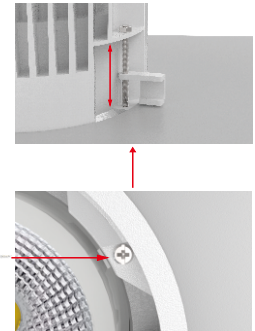

Our Design-DRIZO-W Series



CB IP54 UGR <19

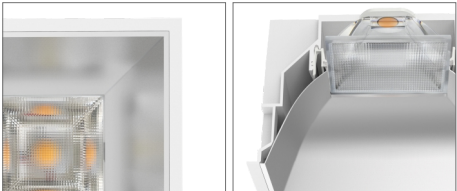
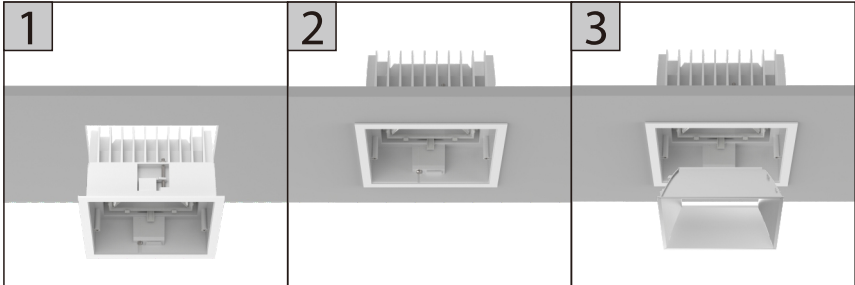
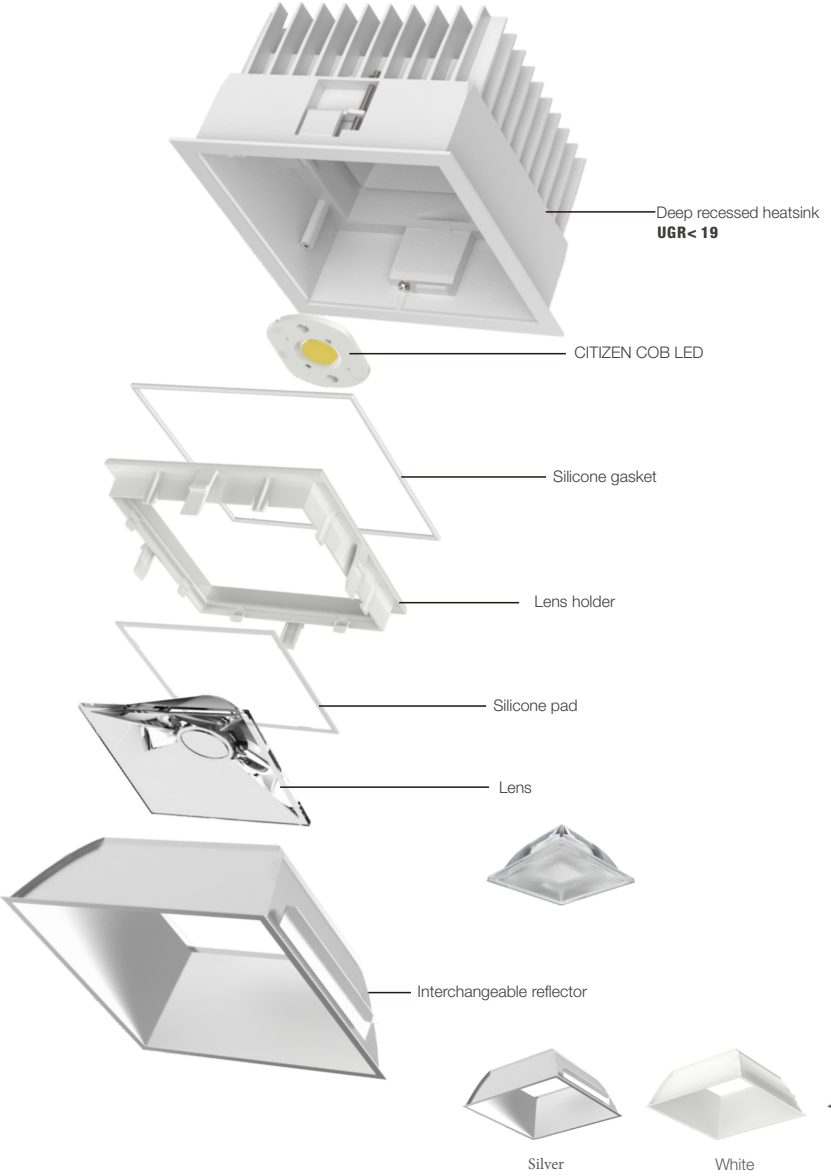

- Focus on every detail
- Low glare for optimal eye comfort

