

TELE-24W

D110xL77 mm 24W Max

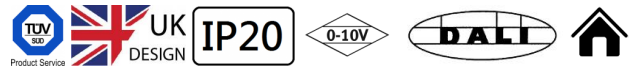

LED track light Feature:

Housing: die-cast aluminium with Anti-glare reflector and diffusor system made of PMMA
Roated Through 350° and Tilted up to 90°.







Power Connection: Pole Terminal .

LED module: LUMINUS SMD, CRI>90, LM-80 performance approval >50,000 hours. Integrated-Type
ELV , 0-10V, DALI, DMX and RDM LED constant current control gear.

TELE-24W

D110xL77 mm 24W Max

Technical Data

Luminaire Type- 安裝方式 Tipo de luminaria	Track Mounted Type 軌道燈具 Tipo de huella Montado
Dimension-尺寸-Dimensión	DIA 110 x L: 77 mm
QTY of LEDs-燈珠數量-CANT de LEDs	6 pcs LEDs
Input Voltage-輸入電壓-Voltaje de entrada	AC220-240V 50/60HZ
Power Consumption Max-燈具功率 Consumo de energía Max	<ul style="list-style-type: none"> • 4W • 8W • 12W • 24W
LED Driver Type LED驅動款式 Tipo de controlador LED	Remote-type LED Driver--Constant Current LED Driver: Refer to LED driver specification 請參閱LED驅動器規格 Consulte la especificación de controlador de LED 1. ON/OFF Switch AC220-240V 50/60HZ @ Integrated-type 2. ELV Dimming Driver (5-100%) AC 100-120V 50/60Hz or AC 200-240V 50/60HZ 3. 0-10V Dimming Driver AC100-240V 50/60HZ 4. Dali Dimming Driver AC100-240V 50/60HZ 5. DMX Driver AC100-240V 50/60HZ 6. RDM Driver AC100-240V 50/60HZ 7. Emergency Backup >2 hours or >3 hours @ < 24 charger hours 應急電池/Copia de seguridad de emergencia
LED Driver Features 驅動特性 Funciones del controlador de LED	POWER FACTOR : PF>0.90 @ Full Load @12W @24W TOTAL HARMONIC DISTORTION: THD< 20% @12W @24W LIFE HOUR : 50,000 Hours
Control Protocol-控制協議 Protocolo de Control	0-10V / Dali / DMX 512 / RDM / ZIGBEE Wireless Control
Beam Angle 光束角 ángulo de haz	<ul style="list-style-type: none"> • 8° • 15° • 24° • 30° • 50°
Light Source Brand-光源品牌-Fuente de luz de marca	LUMINUS - (Photobiological safety-IEC 62471 'Risk Group 1' (low risk))
"Lumen Maintenance LM-80 Reported by TM-21"@ 25°	1. L90(10k) = 50,700 hrs 2. L80(10k) > 63,500 hrs 3. L70(10k) > 63,500 hrs
LED Life-LED壽命-La vida del LED	>60,000 hours
Color Temperature -色溫 Temperatura del color	2700K / 3000K / 4000K / 5000K / 6500K
Color Rendering Index-顯色指數 Índice de reproducción cromática	<ul style="list-style-type: none"> • >80 • >90
Chromaticity Tolerance (initial Macadam) 色度容差 (初始Macadam) Tolerancia de cromaticidad (Macadam inicial)	Standard Deviation Colour Matching < 3 SDCM 標準偏差配色 < 3 SDCM Coincidencia de color estándar Desviación < 3 SDCM
Luminaire Efficacy 燈具效率 La eficacia de la luminaria	<ul style="list-style-type: none"> • 105 Lm/w(2700K), • 105 Lm/w(3000K), • 110 Lm/w(4000K), • 115 Lm/w(5000K), • 115 Lm/w(6500K),
LED Source Luminous Efficacy LED光源光效 Fuente luminosa LED Eficacia	<ul style="list-style-type: none"> • 130 Lm/w(2700K), • 130 Lm/w(3000K), • 140 Lm/w(4000K), • 150 Lm/w(5000K), • 150 Lm/w(6500K),
Housing materials-外殼材料 Materiales de la carcasa	Die-cast aluminum and acrylic 壓鑄鋁和亞克力 Fundición de aluminio y acrílico
Housing Color 外殼顏色 color de la carcasa	Matte white / Matte black 啞光白色 / 啞光黑色 Blanco mate / Matte black
Ingress Protection-防護等級 Protección de ingreso	IP20 - (IEC 60529)
Environment-使用環境-medio ambiente	Indoor
Operating Humidity -工作濕度 Humedad de funcionamiento	0~90%, non-condensing-不結霜 sin condensación
Operating Temperature Range / 工作溫度範圍 Rango de temperatura de funcionamiento	-30 °C / +50 °C
Comply Testing Standard 符合測試標準 Cumplir el estándar de prueba	LED Luminaires: IEC 60598-1 / IEC 60598-2-2 / Photometric data-IES format LED Driver: EN 55015 / IEC 61000-3-2 / IEC 61347-1 / IEC 61347-2-13 / IEC 61547
Certification-認證-Certificación	     

Project	Fixture#	Date
		Firm



Ordering Information

Choose the option that suits your need and write its corresponding code on the appropriate line to form the product code.

Example product code: [TELE-24W](#)

TELE-24W - - _____
LED Driver Type

LED Driver Type	
Code	Description
4W	4W
8W	8W
12W	12W
24W	24W

BEAM ANGLE

8°

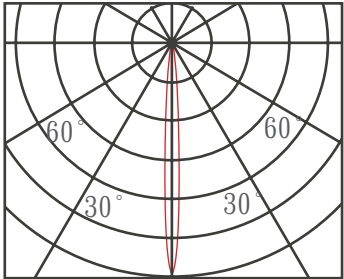

15°

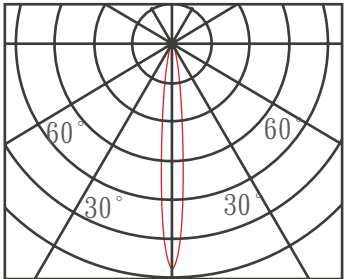

24°

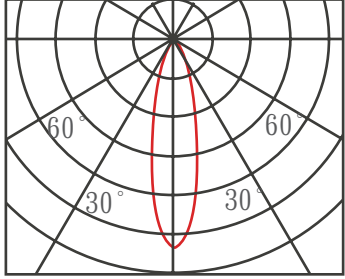

36°

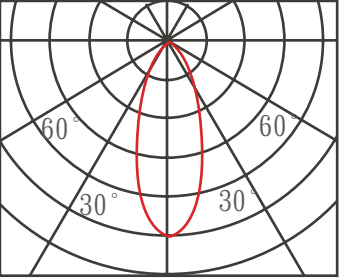

50°

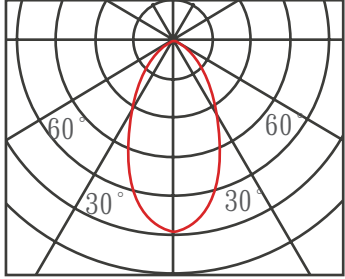

Technical Drawing

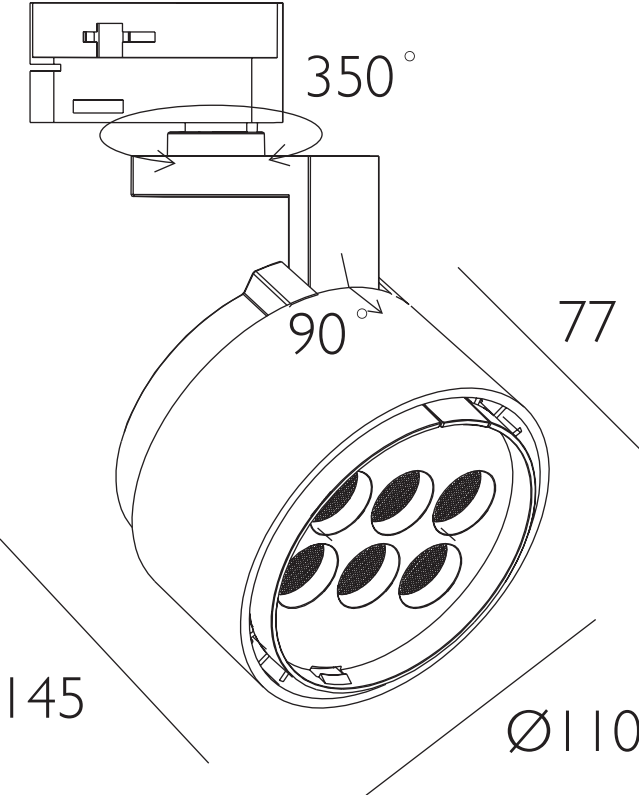

Unit: mm