

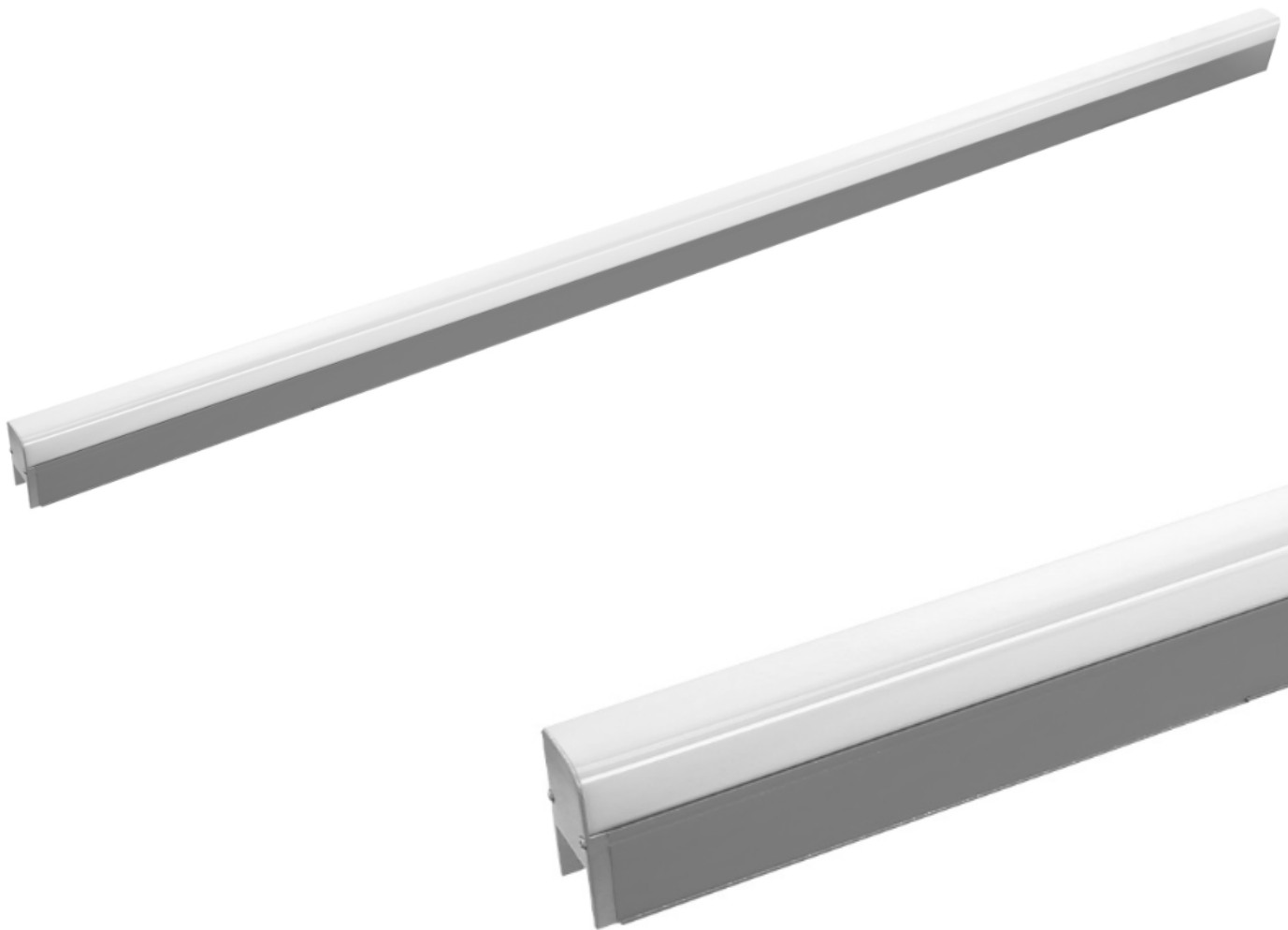





## LACHO

W:25mm 20W/M Max IP65



## Technical Data

Luminaire Type/ 安裝方式 Tipo de luminaria	Surface Mounted or Tilted-Angle- Type 130° rotation 表面固定或可調傾斜角度型-130° 旋轉 Montaje en superficie o ángulo inclinado - Tipo 130 ° de rotación
Color -顏色-Color	RGBW (White: O: 2700K W: 3000K N: 4000K D:5000K C: 6500K) RGB TW: Tunable White ( 2700K to 6500K) MONO:2500K / 2700K / 3000K / 4000K / 5000K / 6500K
Power Consumption Max 燈具最大功率 Consumo de energía Max	• 250mm : 4W • 500mm : 8W • 600mm : 10W • 1000mm: 20W • 1500mm: 25W
Input Voltage / 輸入電 /Voltaje de entrada	DC24V
Pixels & DMX Channels //Meter if Need 像素和DMX 通道/米 如需要 Píxeles y canales DMX // Metro	1Pixel (1 DMX Channel @ Mono; 3 DMX Channel @ RGB; 4 DMX Channel @ RGBW; 2 DMX Channel @TW ) 8Pixels(4 DMX Channel @ Mono; 24 DMX Channel @ RGB; 32 DMX Channel @ RGBW; 16 DMX Channel @TW )
Control Protocol-控制協議 Protocolo de Control	Built- In DMX 512 Remoted LED Driver: ON/OFF Control ; 0-10V Dimming Dali Dimming
Color Range / When DMX512 Control 顏色範圍/ DMX512 控制 Gama de colores	16.7 Million additive RGB colors or RGBW colors 1670萬顏色 使用RGB或RGBW LED 16.7 Millones de colores aditivos RGB; RGBW
Mono, RGB or RGBW Color Resolution with Gamma correction 單色, RGB, RGBW顏色經過伽馬校正的分辨率 Resolución de color mono, RGB o RGBW con corrección gamma When DMX512 Control	16-bit gray scale control and Gamma correction, supports up to 65,536 gray scales for color depths 16位灰度控制, 支持高達65, 536個灰度級的顏色深度 control de escala de grises de 16 bits, soporta hasta 65.536 escalas de gris para profundidades de color
Beam Angle/光束角 ángulo de haz	120°
Light Source Brand/光源品牌 Fuente de luz de marca	OSRAM SMD LED
Color Rendering Index-顯色指數 Índice de reproducción cromática	>80 @ White LED >90 @ White LED
Lumen Maintenance Reported by TM-21 @ 25°C TM-21 光衰壽命@ 25°C Mantenimiento del lumen informado por TM-21 @ 25°C	L70 > 53,500 hrs
LED Life/LED壽命 La vida del LED	>50,000 hours
MacAdam Ellipses Binning 麥克亞當橢圓分級 Mac Adam binning ellipse	Standard Deviation Colour Matching < 3 SDCM 標準偏差配色< 3 SDCM Coincidencia de color estándar Desviación < 3 SDCM
Luminaire Efficacy-燈具效率 La eficacia de la luminaria	80 Lm/w(2500K) @ MONO 90 Lm/w(2700K) @ MONO 110 Lm/w(3000K) @ MONO 120 Lm/w(4000K) @ MONO 120 Lm/w(5000K) @ MONO 120Lm/w(6500K) @ MONO 48 Lm/w@ RGB 55 Lm/W @ RGBW 80 Lm/w @ TW -Tunable White
LED Source Luminous Efficacy-LED光源光效 Fuente luminosa LED Eficacia	130 Lm/w(2500K) @ MONO 130 Lm/w(2700K) @ MONO 130 Lm/w(3000K) @ MONO 140 Lm/w(4000K) @ MONO 150 Lm/w(5000K) @ MONO 150 Lm/w(6500K) @ MONO 65 Lm/w@ RGB 70 Lm/W @ RGBW 140 Lm/w @TW -Tunable White
Housing materials/外殼材料 Materiales de la carcasa	6063 extruded aluminium & Anti UV Opal Polycarbonate Diffuser 6063擠壓鋁和 抗紫外線乳白PC擴散乳白罩 Difusor de aluminio extruido 6063 y difusor de policarbonato opal anti UV
Housing Color/ 邊框殼顏色 Color de la carcasa	Anti-corrosion Protection Anodised Aluminium Titanium 抗腐蝕陽極氧化鋁鈦 Aluminio anodizado titanio Optional -Powder Coating Powder Coated in Silver Grey- UV Resistant plaster powder coating for Anti-corrosion Protection 銀灰色粉末塗料 (抗紫外線和抗腐蝕) Recubrimiento en polvo en gris plateado - Recubrimiento en polvo de yeso resistente a los rayos UV para protección anticorrosión
Ingress Protection/ 防護等級Protección de ingreso	IP65
Operating Temperature Range / 工作溫度範圍 Rango de temperatura de funcionamiento	-20 °C / +50 °C
Operating Humidity -工作濕度 Humedad de funcionamiento	0~100%, non-condensing-不結霜 sin condensación
Dimension/尺寸Dimensión/ (Lx W x H)	Refer to drawing
Comply Testing Standard 符合測試標準 Cumplir el estándar de prueba	EN/ IEC 60598-1;EN/IEC 60598-2-1;EN/IEC 62471 (RG1) ;EN/IEC 62493;EN/IEC 62031;IEC TR 62778; IEC62262; IEC62722-1;IEC 62722-2-1 RoHS CIBSE TMS or IES TM21-L70 EN 55015; EN/IEC 61547 ;EN/IEC 61000-3-2; EN/IEC 61347-1;EN/IEC 61347-2-13;EN/ IEC 62384
Certification-認證-Certificación	    

Project	Fixture#	Date
		Firm



## Ordering Information

Choose the option that suits your need and write its corresponding code on the appropriate line to form the product code.

Example product code: [LACHO-18W](#)

LACHO - - \_\_\_\_\_  
Power Consumption

Power Consumption	
Code	Description
<a href="#">4W</a>	4W@L:250mm
<a href="#">5W</a>	5W@L:300mm
<a href="#">8W</a>	8W@L:500mm
<a href="#">10W</a>	10W@L:600mm
<a href="#">20W</a>	20W@1000mm
<a href="#">25W</a>	25W@L:1500mm

# BEAM ANGLE

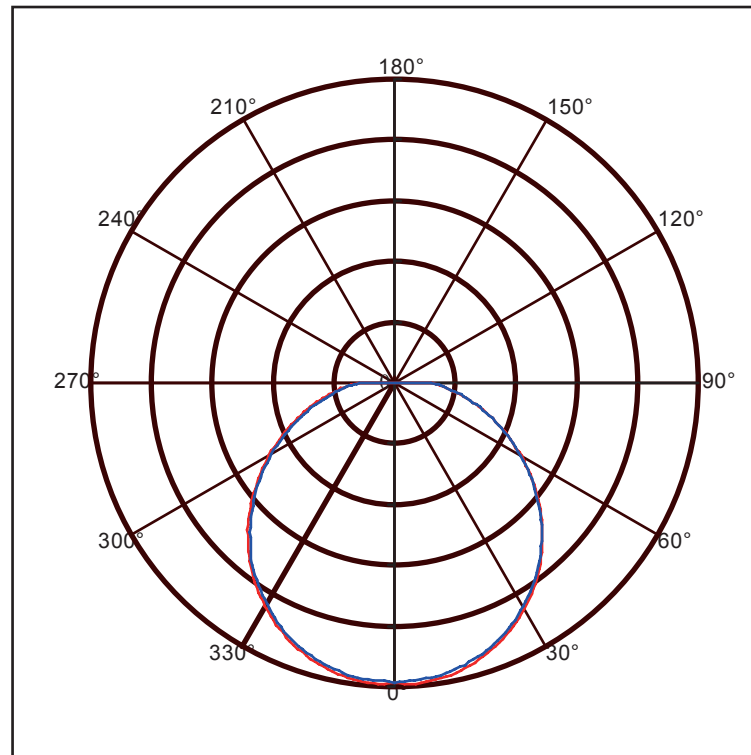

Technical Drawing

L: 250 / 500/ 600/1000mm

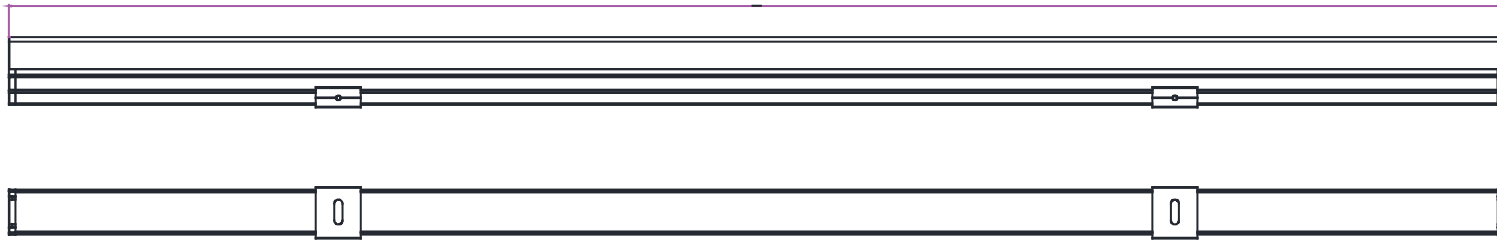

Unit: mm

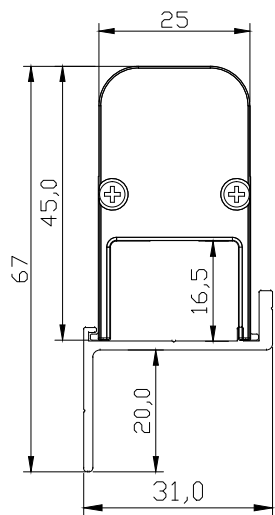

Surface Mount Bracket -A

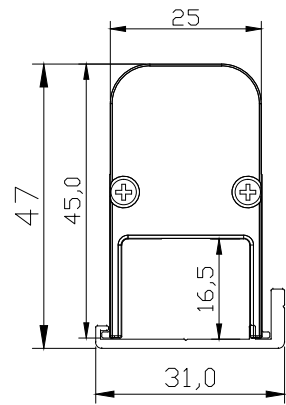

Surface Mount Bracket -B

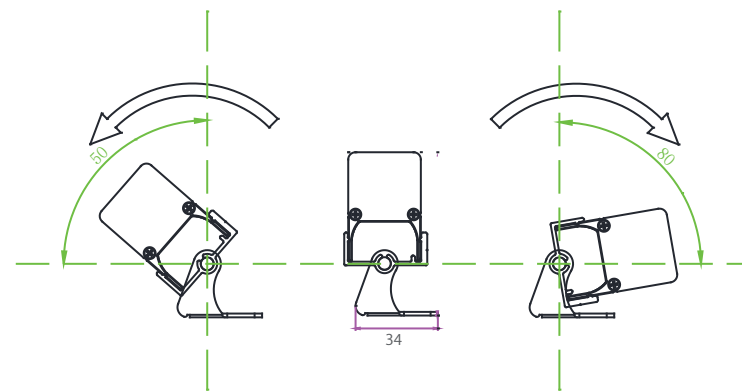

Adjustable Bracket C  
Rotation: +50deg / -80deg

Detail Plan